

# Warnings

1. Only connect this unit to a 12V DC power supply with negative grounding.

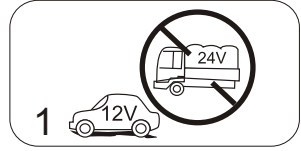

2. Never install this unit where the operation for safety driving is restrained.

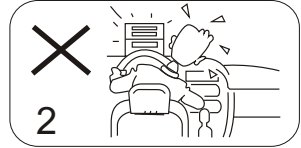

3. Never use the video display function in the front when driving to prevent the violation of laws & regulations and also to reduce the risk of traffic accident except using the rear view video camera.

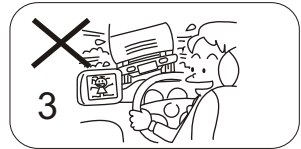

4. Never expose this unit, amplifier, speakers to moisture or water to prevent electronic sparks or fires.

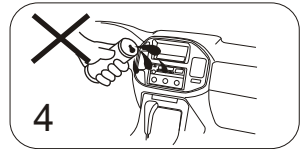

5. Please don't change the fuse in the power cord without professional guidance, improper fuse may cause damage to this using unit or even cause fire.

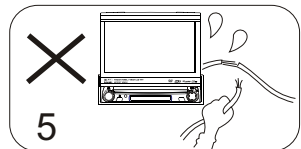

6. Please power off this unit at once and send it back to the after-sales service center or the dealer / distributor you purchased from if one of the following symptoms is found:

- (a) No audio output;
- (b) No image output;
- (c) Water or other obstacle enters the unit;
- (d) Smoking;
- (e) Peculiar smell.

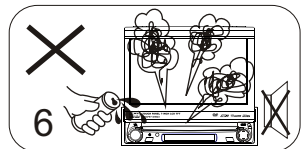

7. To ensure safe driving, please adjust the volume to a safe and comfort level in case of emergency situations.

# Precautions

1. Never disassemble or adjust the unit without any professional guide. For details, please consult any professional car shop / dealer for inquiry.
2. If the front panel or TFT monitor is squalid, please use a clean silicone cloth and neutral detergent to wipe off the spot. Using a rough cloth and non-neutral detergent such as alcohol for cleaning may result in scratching or decoloration to the applicant.
3. If any abnormal behavior of the unit is found, please refer to trouble shooting guide of this manual. If no relevant information is found, please press the [RESET] key on the front panel to resume factory default.
4. If you have parked the car in hot or cold weather for a long time, please wait until the temperature in the car becomes normal before operating the unit.
5. Using in-car heater in low temperature environment may result in beads coagulate inside the unit, DO NOT use the unit in this situation, eject the disc and wipe off the bead on the disc. If the unit still doesn't work after a few hours, please contact with after-sales service center.
6. No fierce impact to the LCD monitor when it is in open position for preventing the damage to any mechanisms inside.
7. To prevent the damage to the screen, avoid touching it with sharp objects.
8. The monitor employs auto motorizing mechanism, please don't push, pull, or swivel the monitor manually to prevent damage to the core mechanism.
9. To provide a clear demonstration and an alternative for easy understanding to the operation of this unit, graphic illustrations are used. However, these illustrations are some different from the actual images displayed on the screen.
10. During operating the unit, “” will display if the current operation is not available or illegal.
11. Operate the unit correctly according to this manual to prevent unnecessary problem. The guarantee won't be valid if the problem is caused by inappropriate operation.

# Declaration

**This product incorporates copyright protection technology that is protected by U.S patents and other intellectual property rights. Use of this copyright protection technology must be authorized by Macrovision, and is intended for home and other limited viewing uses only unless otherwise authorized by Macrovision.**

**Reverse engineering or disassembly is prohibited.**

# Contents

## Before using

Front Panel.....	01
Remote Control.....	03

## Basic operations

Power on/off.....	05
Mute.....	05
Volume adjustment.....	05
Open SOURCE MENU.....	05
Playing source selection.....	05
Display system time.....	06
Using the TFT monitor.....	06
Reset the unit.....	06

## Radio mode

Select radio as playing source.....	07
Select one radio band.....	07
Auto tuning.....	07
Manual tuning.....	07
Auto save.....	07
Manual save.....	08
Preview scan .....	08
Recall the stored stations....	08
Local seeking.....	08

## Disc mode

Insert a disc.....	10
Eject the disc.....	10
Touch screen controls.....	10
Onscreen control buttons.....	11
Suspend playback.....	12
Stop playback.....	12
Display file list.....	12
Fast playback.....	12
Previous / Next.....	12

Change folder.....	13
Repeat playback.....	13
Repeat A-B.....	13
Random playback.....	13
Intro playback.....	14
Direct search.....	14
GOTO search.....	14
DVD MENU and TITLE.....	15
Select subtitle language.....	15
Select multi-angle views.....	15
Select audio channel .....	15
PBC function.....	15
Zoom in/out.....	16
Rotate picture.....	16
Playback information.....	16

## SD/USB mode

Select SD/USB as playing source.....	18
Using the touch screen controls.....	18
Onscreen control menus.....	18
Stop playback temporarily....	18
Stop playback entirely.....	18
Display file list.....	18
Fast forward/reverse.....	18
Play the next or previous file.....	18
Repeat playback.....	19
Random playback.....	19
Intro playback.....	19
Search for a particular file....	19

# Contents

GOTO search.....	19
Zoom in/out.....	19
Rotate picture.....	19
Select picture slide mode.....	19
Playback information display.....	19

## Bluetooth mode

Select Bluetooth as playing source.....	20
Function icons.....	20
Work modes of Bluetooth module.....	20
Phone mode.....	20
Music mode.....	22

## TV mode

Select TV as playing source.....	24
Auto search.....	24
Auto search.....	24
Manual save.....	24
Preview scan.....	24
Change TV channel.....	24

## Other modes

AUX.....	25
Camera.....	25

## Setup

Setup procedures.....	26
General.....	26
Language.....	27
Audio.....	27

Bluetooth.....	28
Rating.....	28
Hardware.....	30
P.VOL.....	30
TS CAL.....	30
SWC .....	31

<b>EQ</b> .....	32
-----------------	----

<b>Troubleshooting</b> .....	33
------------------------------	----

## Device connection

Notes of connection.....	35
Control Cables.....	36
Parking Brake Cable Connections.....	37
Reverse Drive Cable Connections.....	37

## Installation and uninstal

Notes of installation.....	38
Unit installation.....	39
Trim Ring installation.....	40
Uninstall.....	40

<b>Specifications</b> .....	41
-----------------------------	----

## Appendix

Region Code.....	43
Cautions of disc using.....	43
Wiring Diagram.....	44

# Before using

## Front Panel

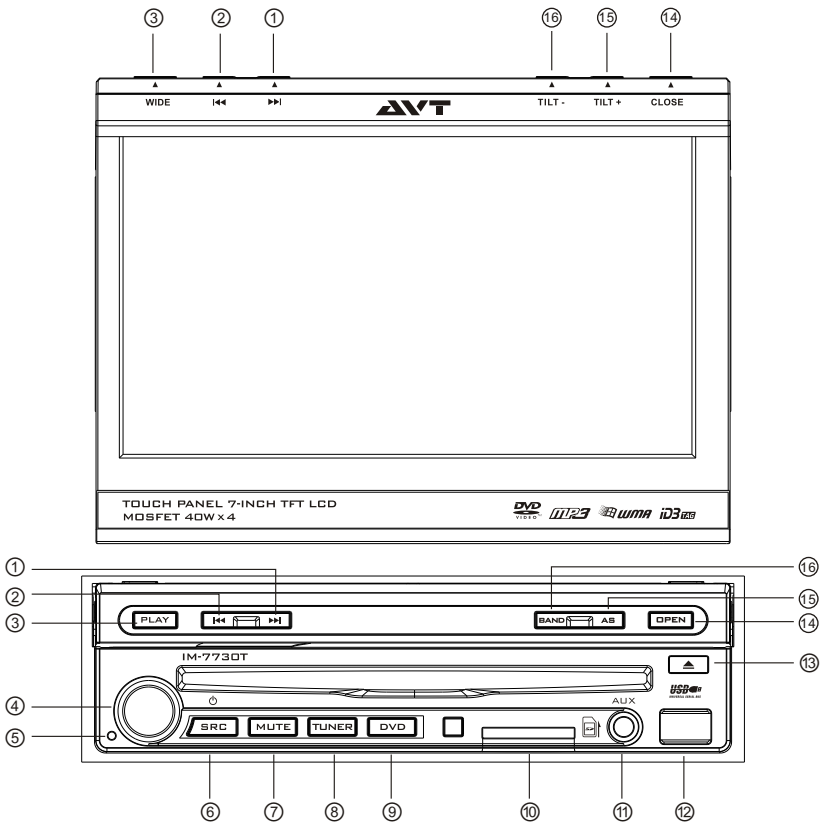

1. [▶▶] Key: Next / Move cursor to the right
2. [◀◀] Key: Previous / Move cursor to the left
3. [PLAY/WIDE] Key: Play ↔ Pause / Change play mode
4. [VOL] Knob Key: Adjust volume / Pop-up EQ menu
5. [Reset] button: Reset the unit
6. [P/SRC] Key: Unit power / Change work mode / Open Source Menu
7. [MUTE] Key: Mute audio outputs
8. [TUNER] Key: Switch to RADIO mode from other source
9. [DVD] Key: Switch to DVD mode from other source

## Before using

- 10.SD CAD Slot
- 11.AUX IN jack
- 12.USB Slot
13. [▲]Key: Eject disc
- 14.[OPEN/Close] Key: Open / Close the TFT monitor
- 15.[AS/TILT+] Key: Auto Save/Increase display angle
- 16.[BAND/TILT-] Key: Change radio band/Decrease display angle

# Before using

## Remote Control

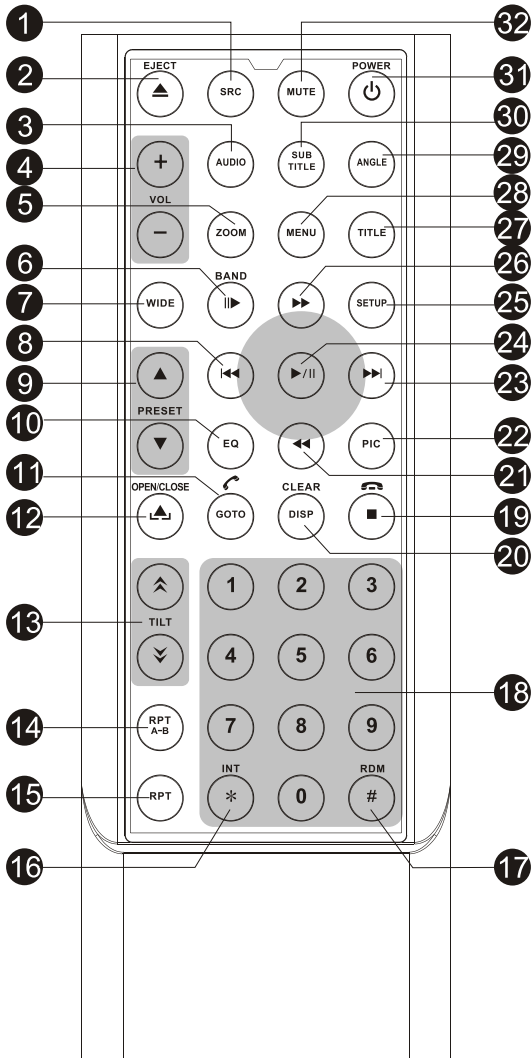

**Note:**

Your remote control may differ slightly from the one pictured here.  
The above diagram is for illustrative purpose only.

# Before using

1. [SRC] Key: Select playing source
2. [EJECT] Key: Eject disc
3. [AUDIO] Key: Select DVD dialogue language
4. [VOL+/-] Key: Adjust volume
5. [ZOOM] Key: Image zoom in/out
6. [BAND/||▶] Key: Select radio band / Slow Playback
7. [WIDE] Key: Change display mode
8. [◀◀] Key: Auto search / Previous / Move cursor to the left
9. [PRESET] Key: Select preset radio station or TV channel
- 10.[EQ] Key: Open EQ setting menu
- 11.[GOTO/☞] Key: GOTO search /Call
- 12.[OPEN/CLOSE] Key: Open or close the TFT monitor
- 13.[TILT] Key: Adjusting the TFT monitor tilting angle
- 14.[RPT A-B] Key: A-B repeat
- 15.[RPT] Key: Repeat playback
- 16.[INT] Key: Intro playback
- 17.[RDM] Key: Random playback
- 18.[0~9] Key: Numeric keys
- 19.[■/⏏] Key: Stop playback/ Hangup
- 20.[DISP/CLEAR] Key: Display information/ Clear information
- 21.[◀◀] Key: Fast reverse/ Move cursor down
- 22.[PIC] Key: Image setting
- 23.[▶▶] Key: Auto search / Next / Move cursor to the right
- 24.[▶/■] Key: Play / Pause / Enter
- 25.[SETUP] Key: Setup menu
- 26.[▶▶] Key: Fast forward / Move cursor up
- 27.[TITLE] Key: DVD TITLE
- 28.[MENU] Key: DVD MENU / PBC
- 29.[ANGLE] Key: Select view angle
- 30.[SUBTITLE] Key: Select DVD subtitle language
- 31.[POWER] Key: Unit power
- 32.[MUTE] Key: Mute audio outputs

# Before using

## Notes of remote control using

- 1) Aim the remote control at the remote sensor on the unit.
- 2) Remove the battery from the remote control or insert a battery insulator if the battery has not been used for a month or longer.
- 3) DO NOT store the remote control under direct sunlight or in high temperature environment, or it may not function properly.
- 4) The battery can work for 6 months under normal condition. If the remote control can't work, please change the battery.
- 5) Use “button shaped” lithium battery “CR2025” (3V) only.
- 6) DO NOT recharge, disassemble, heat or expose the battery in fire.
- 7) Insert the battery in proper direction according to the (+) and (-) poles.
- 8) Store the battery in a place where children cannot reach to avoid the risk of accident.

## Uninstall Battery

Slide out the battery compartment tray at the bottom on the back of the remote control.

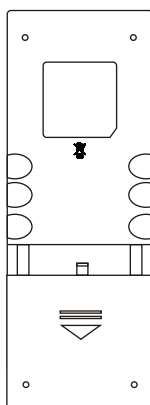

↓ PULL OUT

## Install Battery

Use button-shaped lithium battery “CR2025 (3V)” only. Insert the battery to the battery tray with proper direction according to the (+) and (-) poles.

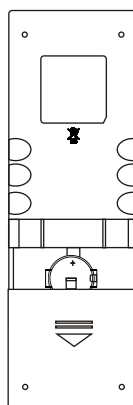

↑ PUSH IN

# Basic operations

## Power on / off

Press any key on the front panel or the [POWER] key on the remote control to turn on the power under standby mode. The unit goes back to the last status after power on.

Press and hold the [SRC] key on the front panel or press the [POWER] key on the remote control to turn off the power under work mode.

## Mute

Press the [MUTE] key on the front panel or remote control to mute the volume from the unit.

### **Notes:**

- ① *Doing the operation above again or adjusting volume will release muting.*
- ② *Mute icon winks on the TFT during muting.*

## Volume adjustment

Turn the volume knob on the front panel or press the [VOL] key on the remote control.

The adjustable range of volume is 0 to 40.

## Open SOURCE MENU

Press the [SRC] key on the front panel or remote control or touch the top left corner of the screen to open the SOURCE MENU.

Do the above operation again to return to the original source.

## Playing source selection

Open the SOURCE MENU, and then touch the source you desired or select one source by moving the cursor and then confirm.

### **Notes:**

- ① *Playing source selection means selecting work mode, such as DVD mode, Radio mode, Camera mode, etc.*
- ② *When some devices are not ready, they cannot be selected.*

## Display system time

Press and hold the [DISP] key on the front panel to switch the display information between system time and playing source when the TFT monitor is closed.

## Using the TFT Monitor

### Open / Close monitor

Press the [OPEN/CLOSE] key on the front panel or remote control to push the display panel out or in.

### Change the monitor tilt angle

Due to the inherent character of LCD, you will get different vision impressions when you watch it from different angles.

The display angle of this unit can be changed; hence you can select the best angle where you can get the best vision impression.

Press the [TILT] key on the display panel or the remote control to adjust the tilt angle one step at a time.

Press and hold the [TILT] key on the display panel or the remote control to adjust the tilt angle continuously.

### Change aspect ratio

Press the [WIDE] key on the display panel or remote control to adjust the aspect ratio.

### Image setting

(1) Enter image setting mode

Press the [PIC] key on the remote control.

(2) Select one item to adjust

Press the [▶]/[◀] keys on the remote control.

(3) Adjust the value

Press the [▶▶]/[◀◀] keys on the remote control.

(4) Exit image setting mode

To exit image setting mode, repeat the first step or stop operation for some seconds.

## Reset the unit

If the unit can not work correctly, you should reset the unit by pressing the [RESET] button on the front panel.

# Radio mode

## Select radio as playing source

Open the SOURCE MENU and then touch RADIO.

## Select one radio band

Press the [BAND] key on the display panel or remote control or touch the [BAND] icon on the user interface to select one radio band among FM1, FM2, FM3, AM1 and AM2.

## Auto tuning

Press the [▶▶] / [◀◀] key on the display panel or remote control or touch the [▶▶] / [◀◀] icon on the user interface to seek a higher / lower station. To stop searching, repeat the operation above or press other keys having radio functions.

### **Note:**

*When a station is received, searching stops and the station is played. If the unit receives a stereo broadcasting, the indicator light of stereo 'ST' on the TFT or LCD display will be lighted.*

## Manual tuning

During manual tuning, the frequency will be changed in steps.

Press the [▶▶] / [◀◀] key on remote control or touch the [▶▶] / [◀◀] icon on the user interface to tune in a higher / lower station.

Touch the numeric keypad icon(  ) and then touch the numeric buttons to input the radio station frequency numbers.

## Auto save

Only stations with sufficient signal strength will be detected and stored in the memory.

When the monitor is closed, press and hold the [AS/PS] key on the display panel.

When the monitor is opened, touch the [AS] icon on the user interface. To stop auto save, press other keys having radio functions.

# Radio mode

## **Notes:**

- ① *After auto save, the previous saved stations will be overwritten.*
- ② *The unit has 5 bands, such as FM1, FM2, FM3, AM1, AM2, and Each band can store 6 stations; hence the unit can store 30 stations in all.*

## **Manual save**

When one expected radio station has been detected.....

- (1) Press the [MEM] icon on the user interface and the preset menu will be opened.
- (2) Press one preset button among P1~P6.
- (3) If you want to abort, press the [Exit] button.

## **Preview scan**

Preview scan searching is such a process that the searching pauses when a station is received and then played for 5~10 seconds. After being played, the unit continues the process until the whole band is detected. When the monitor is closed, press the [AS/PS] key on the display panel. When the monitor is opened, touch the [PS] icon on the user interface. To stop the process, press other keys having radio functions.

## **Recall the stored stations**

Press one numeric key among 1 to 6 on the remote control or touch an onscreen station button to select the corresponding stored station.

## **Local seeking**

When LOCAL seeking is on, only those radio stations with strong radio signal could be received.

To open or close LOCAL function, press and hold the volume knob on the front panel.

## **Notes:**

- ① *When the local radio station searching is on, the indicator light 'LOC' lights up; whereas the light goes off.*
- ② *The number of radio stations that can be received will decrease after the local seeking mode is on.*

# Disc mode

## Insert a disc

Upon inserting a disc, the unit will switch to disc mode automatically.

### Notes:

- ① Please confirm whether there is a disc in the unit before you insert another one.
- ② Some recorded discs, such as CD-R, CD-RW, DVD-R, DVD+R, DVD-RW, DVD+RW cannot be played back because of different recording status. Otherwise, the discs without being closed could not be played back.
- ③ About the cautions of disc using, please refer to the appendix.

## Eject the disc

Press the [EJECT] key on the front panel or remote control to eject the disc.

You can eject a disc after the unit has been powered off. The unit remains off after the disc is ejected.

## Touch screen controls

The touch key areas for DVD playback are outlined below:

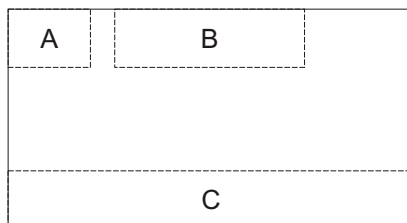

- A - Open SOURCE MENU
- B - Display playback information
- C - Display onscreen control menu

# Disc mode

## Onscreen control buttons

Disc type Icon	MP3/WMA	CD	VCD	DVD	MPEG	Picture
	Numeric keypad	Numeric keypad	Numeric keypad	Numeric keypad	Numeric keypad	Numeric keypad
	Setup menu	Setup menu	Setup menu	Setup menu	Setup menu	Setup menu
	/	Fast forward	Fast forward	Fast forward	Fast forward	/
	/	Fast rewind	Fast rewind	Fast rewind	Fast rewind	/
	Previous	Previous	Previous	Previous	Previous	Previous
	Next	Next	Next	Next	Next	Next
	Play/Pause	Play/Pause	Play/Pause	Play/Pause	Play/Pause	Play/Pause
	Stop	Stop	Stop	Stop	Stop	Stop
	/	/	A second menu	A second menu	A second menu	/
	Repeat	Repeat	Repeat	Repeat	Repeat	Repeat
	Random	Random	Random	Random	Random	/
	/	/	/	/	/	Rotate
	/	/	Zoom	/	/	Zoom
	EQ setup	EQ setup	EQ setup	EQ setup	EQ setup	EQ setup
	/	/	PBC	/	/	/
	/	/	A-B repeat	A-B repeat	/	/
	/	/	Exit menu	Exit menu	Exit menu	Exit menu
	/	/	Channel switching	Dialog Language	Dialog Language	/
	/	/	/	Subtitle Language	Subtitle Language	/
	/	/	Display information	Display information	Display information	Display information
	/	/	/	DVD MENU	/	/
	/	/	/	DVD TITLE	/	/
	Next folder	/	/	/	/	Next folder
	Previous folder	/	/	/	/	Previous folder

## Suspend playback

Press the [▶||] key on the front panel or remote control or open the onscreen control buttons menu and then touch the [▶||] button.

To resume normal play, repeat the above operation.

## Stop playback

To stop playback, press the [■] key on the remote control or open the onscreen control buttons menu and then touch the [■] button.

When the above operation is executed for the first time, the current playback is paused and the break point is memorized and the playback will resume when you start playback again or switch back from other playing sources. The current playback will cancel if the above operation is executed twice and the playback will start over when you start playback again.

## Display file list

To display the file list of one recorded disc, stop current playback.

## Fast playback

Press the [▶▶]/[◀◀] key on the remote control repeatedly or open the onscreen control buttons menu and then touch the [▶▶]/[◀◀] button repeatedly to change the rate of fast forward/fast reverse.

## Previous / next

Press the [◀◀]/[▶▶] key on the display panel or remote control or open the onscreen control buttons menu and then touch the [◀◀]/[▶▶] button to play the next or previous file.

# Disc mode

## Change folder

Press the [DIR+]/[DIR-] icon on the user interface (you should stop playback first if a video or picture file is played back) to change folder during the playback of one recorded disc containing more than one folder.

## Repeat playback

Press the [RPT] key on the remote control repeatedly or open the onscreen control buttons menu and then touch the [↺] button repeatedly to alter repeat mode according to the following table.

Disc type	Repeat mode
DVD	Repeat Chapter → Repeat Title → Repeat Off
VCD(PBC off)	Repeat Single → Repeat All → Repeat Off
CD	Repeat Single → Repeat Off
MP3/WMA	Repeat Single → Repeat Folder → Repeat Off
MPEG	Repeat Single → Repeat Folder → Repeat Off
Picture	Repeat Single → Repeat Folder → Repeat Off

### Notes:

- ① When a VCD is played back, this function is prohibited if the PBC is on.
- ② Turning off the power or switching playing source to other modes and back will cancel this function.

## Repeat A-B

When a DVD, VCD or CD disc is played back, you can play back the contents between the time points from A to B repeatedly.

Press the [RPT A-B] key on the remote control or open the onscreen control buttons menu and then touch the [A-B] button to set the start point (A) of the repeated section.

Do the above operation again to set the end point of the repeated section.

The selected portion will repeat continuously.

Do the above operation for the third time to cancel this function.

## Random playback

When this function is on, the contents in the disc will be played back randomly.

# Disc mode

Press the [RDM] key on the remote control repeatedly or open the onscreen control buttons menu and then touch the [RDM] button repeatedly to alter random playback mode among 'Random', 'Random repeat', 'Repeat Off'.

## Intro playback

When this function is on, the unit will play back the first 10 seconds of each track of a VCD or CD disc. You can search the file you desired using this function.

Press the [SCN] key on the remote control to activate this function.  
Do the above operation again to cancel this function.

## Direct search

When a DVD, VCD or CD disc is played back, you can search for a particular chapter / track by pressing the numeric keys of the remote control. For example, if you want to select the 15<sup>th</sup> track, you should press numerical key [1] and [5].

## GOTO search

### (1) Enter GOTO search mode

Press the [GOTO] key on the remote control to open search menu.

For DVD, you can search according to title, chapter and time.

For VCD, if PBC function is off, you can search according to time; if PBC function is on, you can search according to track, time and Disc time.

For CD, you can search according to track.

For MPEG files, you can search according to track and time.

For record discs containing MP3 and/or JPG files, you can search according to track(file number).

### (2) Enter search information

Select items by pressing the direction keys on the remote control and enter search information by pressing the numeric keys, such as title, chapter and time.

### (3) Confirm

Press the [Enter] key on the remote control to confirm.

### (4) Exit GOTO search mode

Repeat the above operation until the search menu disappeared or touch the [Exit] button on the menu.

## DVD MENU and TITLE

This function is only available for the DVD discs having "MENU / TITLE". Press the [MENU] key on the remote control or open the onscreen control buttons menu and then touch the [MENU] button to open DVD MENU. You can select audio language, subtitle language and so on for playback. Press the [TITLE] key on the remote control or open the onscreen control buttons menu and then touch the [TITLE] button to open DVD TITLE. You can select a different title for playback.

## Select subtitle language

Press the [SUBTITLE] key on the remote control repeatedly or open the onscreen control buttons menu and then touch the [SUBTITLE] button repeatedly to choose a subtitle language.

## Select multi-angle views

Press the [ANGLE] key on the remote control repeatedly to choose a shooting angle during the playback of a DVD disc or video file containing multi-angle views.

## Select audio channel

For DVD containing multi-language audio files, press the [AUDIO] key on the remote control repeatedly or open the onscreen control buttons menu and then touch the [AUDIO] button repeatedly to change dialogue language.

For VCD and CD, press the [AUDIO] key on the remote control repeatedly or open the onscreen control buttons menu and then touch the [AUDIO] button repeatedly to alter audio channel modes among Left vocal, Right vocal, Mono left, Mono right, Stereo.

### **Note:**

*Left channel and right channel cannot work properly if the audio files are not recorded correctly.*

## PBC function

This function is available for the VCD discs with PBC function (Ver 2.0 or higher).

Press the [MENU] key on the remote control to activate this function. Press again to cancel.

# Disc mode

## Notes:

- ① When PBC is on, playback goes back to the track list and starts from the first track.
- ② When PBC is on, fast motion playback, slow motion playback or skip search is available but repeat playback and searching for a particular chapter or track is prohibited.
- ③ If you do the operation of random playback, scan playback or searching playback when PBC is on, PBC will be off automatically.

## Zoom in/out

To zoom in/out the image being played, press the [ZOOM] key on the remote control or open the onscreen control buttons and then touch the [Q] icon.

## Rotate picture

When one picture file is played back, you can rotate the picture to get proper view angle by pressing the [⤴] icon on the onscreen control buttons.

## Playback information

Touch the top center area of TFT LCD when playing back DVD and VCD discs and the playback information will be displayed on the top area of the TFT.

### For DVD

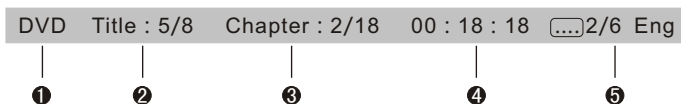

- (1) Disc type.
- (2) DVD Title information. "5/8" indicates that this DVD has 8 titles and the title playing back now is the fifth title.
- (3) DVD Chapter information. "2/16" indicates that current title has 16 chapters and the chapter playing back now is the second chapter.
- (4) Elapsed time of the current title.
- (5) "(...)2/6 Eng" indicates that the subtitle of this DVD has been

# Disc mode

recorded in 6 languages and the language displayed now is the second, that is English.

## For VCD

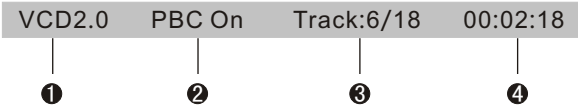

- (1) Disc type.
- (2) PBC function indicator. "PBC On" indicates that PBC function has been activated.
- (3) VCD Track information. "6/18" indicates that this VCD has 18 tracks and the track playing back now is the sixth title.
- (4) Elapsed time of the current track.

# SD/USB mode

## Select SD/USB as playing source

Method 1:



Method 2:

Open the 'SOURCE MENU' and then select 'SD'.

*Notes:*

- ① *The unit will switch to SD card mode or USB mode after a SD card or USB device has been inserted.*
- ② *The unit supports hot swap.*

## Using the touch screen controls

The operation is the same as DVD mode.

## Onscreen control buttons

Onscreen control buttons under SD/USB mode are the same as disc mode.

## Stop playback temporarily

The operation is the same as disc mode.

## Stop playback entirely

The operation is the same as disc mode.

## Display file list

The operation is the same as disc mode.

## Fast forward/Fast reverse

The operation is the same as disc mode.

### **Play the next or previous file**

The operation is the same as disc mode.

### **Repeat playback**

The operation is the same as disc mode.

### **Random playback**

The operation is the same as disc mode.

### **Intro playback**

The operation is the same as disc mode.

### **Search for a particular file**

The operation is the same as disc mode.

### **GOTO search**

The operation is the same as disc mode.

### **Zoom in/out**

The operation is the same as disc mode.

### **Rotate picture**

The operation is the same as disc mode.

### **Select picture slide mode**

The operation is the same as disc mode.

### **Playback information display**

The operation is the same as disc mode.

# Bluetooth mode

Bluetooth is a wireless transmission way for short distance operating at 2.4GHz. The bluetooth module can connect with the mobile phones having bluetooth function. After connecting, you can control your mobile phone through the unit.

As different mobile phones provide different bluetooth functions, so not all of the functions undermentioned are available to different phones. Please read through the operation manual of the mobile phone in use at first.

## Select Bluetooth as playing source

Open the SOURCE MENU and then touch BT.

## Function icons

The function icons of BT are outlined as below.

Icon	Function	Icon	Function	Icon	Function
	Pairing		Disconnect		Dial panel
	Setup		Voice transfer		Mute
MENU	Menu		Ans./Dial		Hangup
	Play/Pause		Stop		Next
	Previous		Phone mode		Music mode

## Work modes of Bluetooth module

The bluetooth module has two work modes, which are phone mode and music mode. Touch the mode switch icon to switch to its corresponding mode. Under phone mode, hand-free, call and other phone functions are available. Under music mode, you can enjoy the music played back by your mobile phone through the speakers in your car and you can control the playback.

## Phone mode

### Pairing

Use this function to establish a connection between the Bluetooth module and your mobile phone.

- ① Switch the work mode of the Bluetooth module to phone mode, open the SETUP menu and select the Bluetooth sub-menu and then set the 'Bluetooth' option to 'On'.

## Bluetooth mode

- ② Turn on the Bluetooth function of your mobile phone and start to search Bluetooth devices.
- ③ After the name of the Bluetooth module appears on the pairing list on your mobile phone, you should select it. At this time, a pairing code is required. The Bluetooth module will exit pairing mode if there is no pairing instruction from your mobile phone during the pairing time (90s) and 'Phone Pairing Fail' is displayed on the screen.
- ④ Enter the pairing code (1234 by default) to initiate the pairing process. The paired mobile phone name will display on the screen.

### Browse call numbers

The Bluetooth module will download phone book and call records from your mobile phone after pairing.

Touch the [MENU] icon to display the Menu list. There are some options on the menu list, including missed calls, received calls, dialed calls and phone book. When you press one of them, the Bluetooth module will get its corresponding information from your mobile phone.

### Make an outgoing call

- ① Browse through the Phone book or call records, touch the number you want to dial and then touch the dial icon to make an outgoing call.
- ② Touch the Dial Panel icon to open dial panel and then touch the numeric buttons to input phone numbers. Touch the [Clear] icon to clear the last digit. Touch the hangup icon to clear the entire numbers or end the conversation. Touch the Ans icon to make an outgoing call.

### Answer an incoming call

The Bluetooth module will switch to phone mode automatically when there is an incoming call and the incoming call number will be displayed on the screen.

If the 'Auto Answer' option of the 'Bluetooth' sub-menu under the SETUP MENU is set to 'On', the unit will answer incoming calls automatically,

# Bluetooth mode

otherwise you should answer them manually.

The call duration will be displayed on the screen after the incoming call has been put through.

## Hangup

While talking, press the hangup key on your mobile phone or touch the hangup icon on the screen to end the conversation.

## Voice transfer

While talking, touch the 'Voice transfer' icon on the screen to transfer audio from the unit to your mobile phone, and touch again to transfer audio from your mobile phone to the unit.

**Note:** *Some mobile phones will transfer audio from the unit to themselves once the incoming call is answered.*

## Microphone mute

While talking, press the microphone mute icon on the screen to mute the microphone built in the unit. Under this condition, the one talking over the telephone with you can not hear what you are saying. Touch the mute icon again to resume microphone functionality.

## Music mode

### Pairing

Before pairing, switch the work mode of the Bluetooth module to music mode. The procedures of pairing under music mode is the same as the phone mode.

### A2DP

A2DP is short for Advanced Audio Distribution Profile. The mobile phones supporting this function can transmit stereo audio, whereas the ones not supporting this function can transmit mono audio only.

After pairing, open the audio player of your mobile phone and set the transmit mode to Bluetooth. At this time, the speakers of your mobile phone will close automatically.

## Bluetooth mode

About how to set the transmit mode of mobile phones to Bluetooth, please refer to the user manual or help document of the mobile phone in use or the audio player software because the audio players of different mobile phones are different greatly.

### **AVRCP**

AVRCP is short for Audio/Video Remote Control Profile. The mobile phones supporting this function can control the playback of a Bluetooth audio player.

After pairing, touch the corresponding icon to control current playback, such as Play, Pause, Stop, Previous, Next.

# TV mode

## Select TV as playing source

Open the SOURCE MENU and then select TV.

## Auto search

To search for a higher / lower TV channel, press and hold the [▶▶] / [◀◀] key on the display panel or remote control.

### **Notes:**

- ① To stop auto searching, press other keys having TV functions.
- ② When a TV channel is received, searching stops and the TV channel is played. If no TV channel is detected, the tuning channel stops at the very beginning channel when the searching process is finished.

## Manual search

Press the [▶▶] / [◀◀] key repeatedly on the display panel or remote control to change TV channel in steps.

## Auto save

Search all TV channels in the whole range and storing the available TV channels automatically.

Press and hold the [▶▶] key on the front panel or remote control to start auto save. To stop this process, press any other keys having TV functions.

## Preview scan

Scan the stored TV channels and play each channel for 10 seconds.

Press the [▶▶] key on the front panel or remote control to start preview scan. To stop this process, press any other keys having TV functions.

## Change TV channel

### **Play the previous / next stored channel**

To play the previous / next stored TV channel, press the [Up] / [Down] key on the remote control.

### **Play a particular channel**

To play a particular TV channel, press the numeric keys of remote control continuously.

## Other modes

### AUX

External peripheral devices with RCA audio and video outputs can be connected with the unit.

To enter AUX IN mode, open the SOURCE MENU and then touch AUX IN.

### Camera

This player is “camera ready”. Before accessing any camera features, you must purchase and install a rear video camera. Once the rear camera is connected and operating properly, the CAMERA source mode will become active. While the camera is not installed, the CAMERA option appears gray, indicating the function is not available.

The playing source will change to 'CAMERA' mode automatically when you reverse your car.

# Setup

## Setup procedures

### (1) Enter setup mode

Press the [SETUP] key on the remote control or touch the setup icon [ ⌘ ] on the user interface.

The following menu appears after entering the setup mode.

The GENERAL sub-menu is highlighted by default.

SETUP MENU				
Bluetooth	General	Language	Audio	Back
Rating	Clock Mode	12Hr		
Hardware	Clock	11:18 AM		
P.VOL	Tuner Region	ORIT		
TS Cal	Beep	On		

### (2) Select one sub-menu

Press the direction keys on the remote control.

### (3) Select one item

Press the [▶▶] / [◀◀] key on the remote control to select one item and then press the [▶|] key to confirm.

### (4) Select one value

Press the [▶▶] / [◀◀] key on the remote control to select one suitable value and then press the [▶|] key to confirm.

**Note:** All following settings can be done by touching the option directly.

## General

- Clock mode
  - 12Hr: the clock displays in the type of 12 hours such as 11:18 AM.
  - 24Hr: the clock displays in the type of 24 hours such as 20:18.
- Clock
  - Adjust the clock displayed on the top right corner of the TFT screen.
- Tuner Region
  - The unit provides several radio systems and you can select a correct radio system according to your country.

# Setup

- Beep

On: Background sound of key-press is on.

Off: Background sound of key-press is off.

## Language

- OSD

Select one language of system menu display.

- DVD Audio

Select one dialogue language of DVD disc.

**Note:**

*If the DVD disc does not contain the selected language, the dialogues you listening to will be in default language.*

- DVD Subtitle

Select one subtitle language of DVD disc.

**Note:**

*If the DVD disc does not contain the selected language, the subtitle will be displayed in default language.*

- Disc Menu

Select one language of DVD MENU display.

**Note:**

*If the DVD disc does not contain the selected language, the DVD MENU will be displayed in default language.*

## Audio

- DRC

Set the dynamic range of Dolby digital DVD discs.

On: Playback more dynamic audio with Bass.

Off: Normal output.

- Loudness

On: Loud mode is on.

Off: Loud mode is off.

## Bluetooth

- Bluetooth

On: Turn on the power of the Bluetooth module.

Off: Turn off the power of the Bluetooth module.

- Auto Answer

On: Answer automatically when one call is coming in.

Off: Answer manually when one call is coming in.

- Connect

Auto: bluetooth module connects with the bluetooth device automatically after disconnecting.

Manual: bluetooth module connects with the bluetooth device manually after disconnecting.

- Pairing code

You should enter the pairing code when the bluetooth module is pairing with another bluetooth device. The original pairing code is 1234 and you can change the pairing code when the bluetooth module is on.

## Rating

Some DVD discs have built-in parental lock which prevents children to watch some scenes as force or eroticism especially.

- Set Password

The original password of the unit is null.

You should set a new password ASAP.

**Method of changing password:**

(1) Open the parental lock

Touch the 'Password' option directly to open the keypad, touch the numeric buttons to enter your old password (initial password for the first time) and then confirm by touching the [ENT] button.

(2) Change the password

Repeat the operation above to enter a 6-digit password (old or new) and then confirm. The new password becomes effective and the parental lock is closed.

# Setup

- Rating

The unit has some watching level as followings:

- (1) Kid safe: A movie rating that is condign to children.
- (2) G: A movie rating that allows admission to persons of all ages.
- (3) PG: A movie rating that allows admission of persons of all ages but suggests parental guidance in the case of children.
- (4) PG-13: A movie rating that allows admission of persons of all ages but suggests parental guidance in the case of children under the age of 13.
- (5) PG-R: PG-related.
- (6) R: A movie rating that allows admission only to persons of a certain age, usually 17, unless accompanied by a parent or guardian.
- (7) NC-17: A movie rating that allows admission to no one under the age of 17.
- (8) Adult: A movie rating that is condign to the adult only.

**Procedures of changing the rating:**

- (1) Open the parental lock

According to the same method mentioned in the first step of changing password.

- (2) Change the rating

Select an appropriate rating from the 'rating' list.

- (3) Close the parental lock

Repeat the operation of the first step to enter a 6-digit password (old or new) and then confirm. The parental lock is closed.

- Load Factory

To restore the default settings relating with DVD playback (e.g.: DVD Audio, DVD Subtitle), press the [RESET] option only.

## Hardware

- Camera In  
Normal: Actual scenes shot by the camera display on the TFT monitor while reverse driving (just like what you are looking).  
Mirror: The mirror images of actual scenes display on the TFT monitor while reverse driving (just like looking from the rearview mirror).
- TFT Auto Open  
Auto: The TFT panel automatically opens when the unit is turned on.  
Manual: When the ignition is turned off, the TFT panel remains open if it was opened previously.  
Off: The TFT panel opens only by pressing OPEN button when the unit is turned on.
- Video input  
NTSC: Set the color system of the TFT screen to NTSC.  
PAL: Set the color system of the TFT screen to PAL.  
AUTO: Set the color system of the TFT screen automatically by the unit according to the input video formats.
- Parking  
On: Image displays only after your car has been parked.  
Off: Image displays at all times.

## P.VOL

P.VOL means Programmable Volume.

You can balance the volume among different audio sources using this function.

- Source  
Select one playing source that you want to set relative volume.
- Level  
You can set relative volume level from -6 to 6.

## TS CAL

When the touch function is not sensitive or valid, you should calibrate the touch screen by this function.

Calibrate the touch screen just following the screen introductions after entering the TS CAL mode.

## SWC

The unit is compatible with the PAC (Pacific Accessory Corporation) steering wheel control adapter SWI-PS. A 3.5 mm female connector (labeled SWC interface) on the back of the head unit allows connectivity to the PAC adapter. Please refer to the instructions included with the PAC adapter for detailed installation information.

- SWC Functions

The following controls are available for most vehicles:

1. Vol Down
2. Vol Up
3. Mute
4. Seek Down/Previous Track/ Preset Down
5. Seek Up / Next Track / Preset Up
6. SRC (Source)
7. Select
8. Band

If additional steering wheel control but buttons are available on the vehicle, function 7 may be assigned the "Select" feature .

This feature/function may not be available on some vehicles.

- Select Operation

If "Select" (function 7) is held down and function 4 is pressed momentarily, Preset Up will be selected.

If "Select" (function 7) is held down and function 5 is pressed momentarily, preset down will be selected.

Audio control allows you to easily adjust the audio system to get the best possible sound effect.

### (1) Enter the EQ setup mode

Press the [SEL] key on the remote control or touch the EQ icon in the user interface and the following interface will display on the screen.

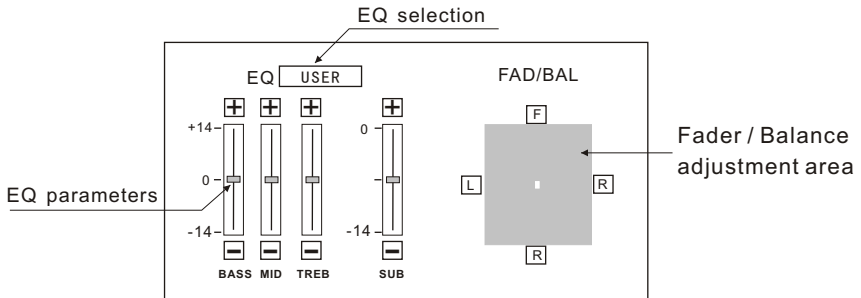

### (2) Select EQ mode

Touch the EQ selection bar repeatedly and the EQ mode will change.

### (3) Adjust EQ parameters

To adjust EQ parameters, touch and drag the EQ parameters adjustment bar.

### (4) Adjust Front/Rear/Left/Right fader and balance

You can adjust front/back/left/right balance of the speaker to get larruping listening effect according to the surroundings and your interest.

To adjust Front/Rear/Left/Right fader and balance, touch and drag the small white point in the Fader/Balance adjustment area.

*Notes:*

- ① *The unit has provided some EQ modes: User, Rock, Hip Hop, Dance, Latin, Rave, Urban, Acoustic.*
- ② *Different EQ reflects in different Bass, Treble and Middle level. The parameters of the EQ modes has been preset and you can not change them besides 'User'.*
- ③ *The EQ mode will change to 'User' automatically when you adjust the value of BASS, TREB or MID under the modes besides 'User'.*
- ④ *The value of SUB is independent of EQ mode and can be adjusted solely.*

# Troubleshooting

What appears to be trouble is not always serious. Please check the following points before calling a service center.

<b>Problem</b>	<b>Cause</b>	<b>Corrective action</b>
<b>General</b>		
Unit can not power on	Unit fuse blown.	Install new fuse with correct rating.
	Car battery fuse blown.	Install new fuse with correct rating.
	Illegal operation	Reset the unit.
Remote control does not work	Battery depleted.	Change the battery.
	Battery installed incorrectly.	Install the battery correctly.
No/low audio output	Improper audio output connection.	Check wiring and correct.
	Volume set too low.	Increase volume level.
	Speakers damaged.	Replace speakers.
	Heavily biased volume balance.	Adjust the channel balance to center position.
	Speaker wiring is in contact with metal part of car.	Insulate all speaker wiring connections.
Poor sound quality or distortion	Piratic disc is in use.	Use original disc.
	Speaker power rating does not match unit.	Replace speakers.
	Wrong connections.	Check wiring and correct.
	Speaker is shorted.	Check wiring and correct.
Tel-Mute malfunction	MUTE wire is grounded.	Check the 'MUTE' wiring and correct.
Unit resets itself when engine is off	Incorrect connection between ACC and BATT.	Check wiring and correct.
<b>TFT monitor</b>		
Monitor does not open automatically	TFT Auto Open is turned off.	Turn TFT Auto Open on.
Warning information is shown at all times	Parking break wiring is not correct.	Check wiring and correct.
Flashing image or interference appears on screen	The color system of DVD disc does not match the monitor.	Adjust the color system of the DVD disc playing back or the monitor in use.
	Piratic disc is in use.	Use original disc.
	Video cable damaged.	Replace cables.
	Improper video signal connections.	Check wiring and correct.

# Troubleshooting

(Continued)

<b>Problem</b>	<b>Cause</b>	<b>Corrective action</b>
<b>Disc playback</b>		
Cannot insert disc	A disc inside the unit already.	Eject current disc and insert new one.
Disc does not play back	Disc is warped or scratched.	Use disc in good condition.
	Disc is dirty or wet.	Clean disc with soft cloth.
	Incompatible disc is used.	Use compatible disc.
	Disc is inserted upside down.	Insert disc with label side up.
	Disc region code is not compatible with unit.	Use disc with proper region code.
PBC cannot be used during VCD playback	PBC is not available on the disc.	Use disc with PBC available.
Repeat or search function is invalid during VCD playback	PBC is on.	Turn PBC off.
<b>Error messages</b>		
No disc	Disc is dirty.	Clean disc with soft cloth.
	Disc is upside down.	Insert disc with label side up.
	No disc inside.	Insert disc.
Bad disc	Disc is dirty.	Clean disc with soft cloth.
	Disc is upside down.	Insert disc with label side up.
Unknown disc	Disc format is not compatible with this unit.	Use disc with compatible format.
Region Error	DVD region code is not compatible with this unit.	Use disc with compatible region code.

# Device connections

## Notes of connection

- This unit is designed to be used in a vehicle with a 12-volt battery and negative grounding. Before installing this unit to a recreational vehicle, a bus, or a truck, make sure the battery voltage is appropriate for this unit to be used, otherwise, install a transformer by professional to convert the output voltage to 12V.
- To avoid short circuit in the electrical system, ensure that the negative battery cable is disconnected before installation.
- To prevent short circuit in the wiring and damaging to this unit, secure all wirings with cable clamp or adhesive tape. Route the wirings in a secured, out of heating place without touching any moving parts such as gear shift, handbrake, and seat rails to prevent the wiring insulation being melted / wore off.
- Never pass the yellow power cord through the installation hole into the engine compartment and connect to the car battery. Otherwise, a high possibility of serious short circuit to the electrical system may be occurred.
- Replacing a new fuse with 10A rating when the old one is broken, using no fuse or fuse with improper rating may cause damage to this unit or even fires. If a proper fuse is installed and electrical problems still occur, please contact with any professional car shops for inquiry.
- DO NOT connect other equipments with the car battery to avoid battery overheating.
- Please make sure all the wiring connections & the cables of the speakers are well-insulated. Otherwise, this unit may be damaged by short circuit.
- If there is no ACC available, Please connect ACC lead to the power supply with a switch.
- If an external power amplifier is connected, please don't connect P.CONT lead to the power lead of the external power amplifier, otherwise, electric spark or other damage may be resulted.
- Never ground the speaker output to prevent the damage to the built-in power amplifier.
- The minimum rating of the speakers connected to this unit is 50W with 4 to 8Ω impedance.

## Control Cables

### Auto Brightness Control

To avoid the display being too bright at night time, if the headlight cable is connected to ILLUMI, turning on the headlight will dim the backlight of the TFT LCD and vice versa.

### Telephone Mute

If the MUTE cable is connected to a car phone, other audio outputs mute when one call is received by the car phone.

### Reverse Driving

If a rear view camera is connected with the unit, the playing source switches to CAMERA automatically when you start reverse driving. As the reverse driving is done, the playing source switches to the previous.

### Parking Brake

- 1) If "PRK SW" cable is connected to hand brake switch, video display on the TFT monitor will be controlled by this function. Parking cable function ceases when the playing source is CAMERA.
- 2) The monitor displays the blue screen with warning information to prevent the driver watching video contents during driving, but the passengers at the rear seat can watch video contents normally.

# Device connections

## Parking Brake Cable Connections

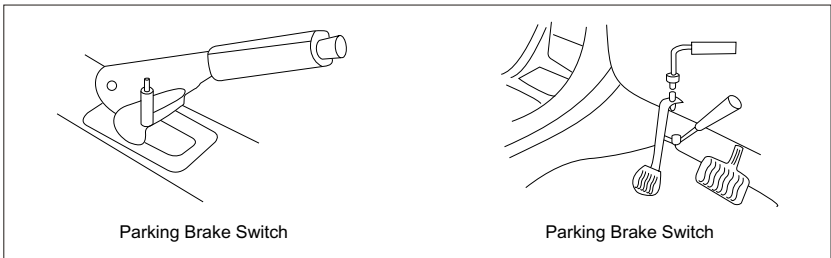
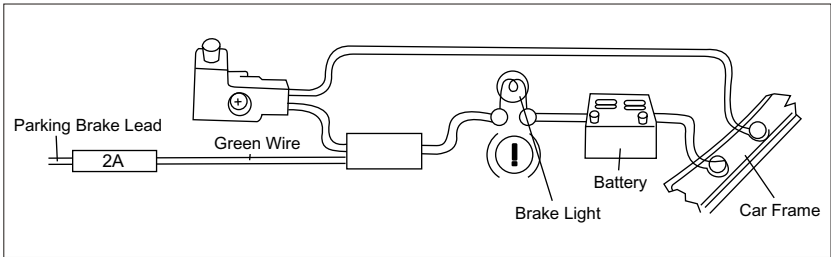

## Reverse Driving Cable Connections

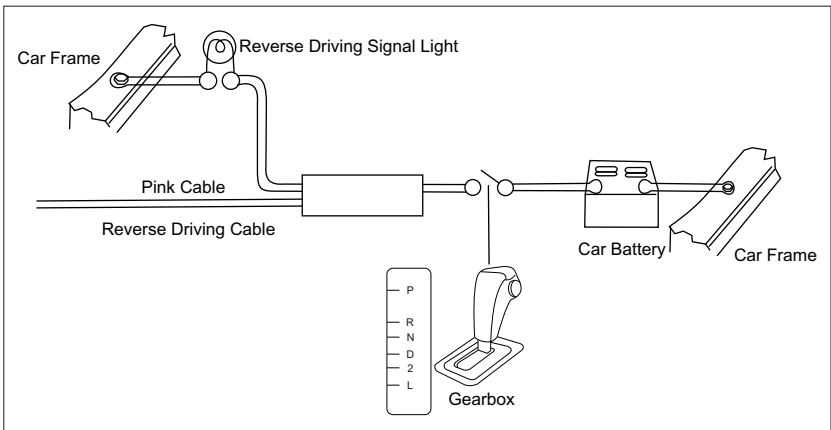

# Installation and uninstall

## Notes of installation

- 1) Before installation, please make sure proper connections are conducted and the unit operates normally. Improper connection may result in damage to the unit.
- 2) Use only accessories designed and manufactured for this unit and other unauthorized accessories may result in damage to the unit.
- 3) Before installation, please fasten all power cables.
- 4) DO NOT install the unit in the place where close to hot area to prevent damage to electrical components such as the laser head.
- 5) Install the unit horizontally. Installing the unit more than 30 degree vertically may result in worse performance.
- 6) To prevent electric spark, connect the positive pole first and then the negative pole.
- 7) DO NOT block the cooling fan exit to ensure sufficient heating dissipation of this unit, or it may result in damage to this unit.

## Unit Installation

### Method A

- (1) Insert mounting bracket into dash board, choose appropriate mounting tab according to the gap width, bending the mounting tab outwards with a screwdriver to fix the mounting bracket in place.
- (2) Use 2 pieces of M5×5 cone shaped screw to fix two assemble bars on both sides of the unit (see picture 1)

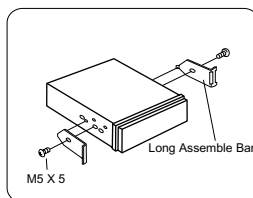

(Picture 1)

- (3) Screw in 1 piece of M5×24 to the hole of the unit back and put on a rubber sheath over the screw. (see picture 2)

# Installation and uninstal

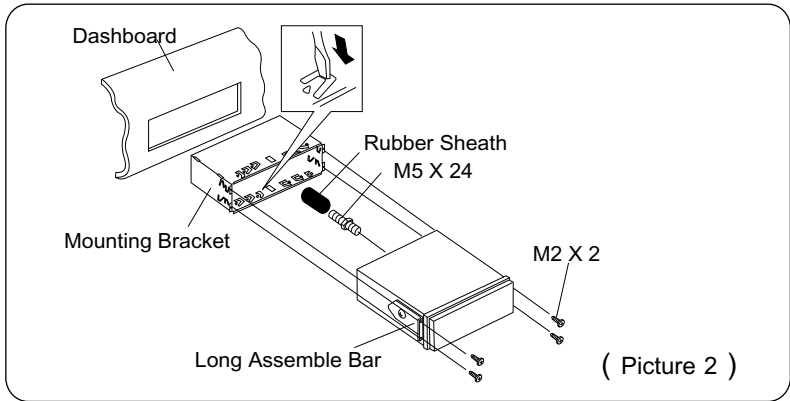

- (4) Insert the unit into the bracket, fasten the  $M4 \times 6$  screw to the fireproofing board available at the back of the dashboard, and use 4 pieces of  $M2 \times 2$  screw to lock the assemble bars and the mounting bracket in position.

## Note:

According to the depth of the opening, use different length of assemble bar accordingly. If the opening is too shallow, the monitor may be extended out 10mm from the dashboard.

## Method B

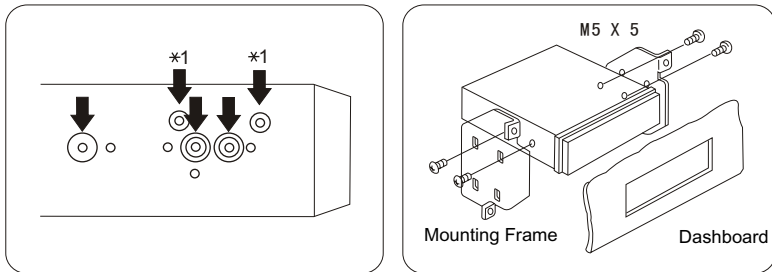

- (1) Insert this unit directly to the opening of the dashboard.
- (2) Place  $M4 \times 3$ ,  $M5 \times 5$  cylindrical screw or  $M5 \times 5$  cone shaped screw through the holes of the mounting frame located inside the opening to holes of the unit and fasten the screws to left & right.

# Installation and uninstall

## Trim Ring installation

Attach the trim ring around the front panel with two indentions on one side facing upwards

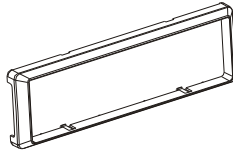

## Uninstall

### Disassemble trim ring

(1) Push the trim ring upward and pull out the upper part.

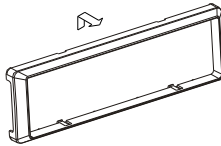

(2) Push the trim ring downward and pull out the lower part.

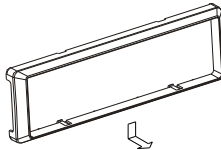

### Disassemble the unit

(1) Unscrew the 4 pieces M2×2 screws.

(2) Use a screwdriver to bend straight the bended mounting tab and tip out the unit from the mounting bracket.

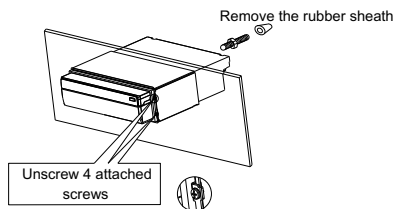

(3) Pull out the unit from the mounting bracket with both hands.

# Specifications

## General

Reference Supply Voltage.....	12V(DC)
Operating Voltage Range.....	10.5 ~ 15.8V(DC)
Max Operating Current.....	10A
Grounding System.....	Car Battery Negative Pole
Installation Dimension(W×H×D).....	178 mm×50mm×(165+25)mm
Installation Angle.....	0°~30°
Net Weight.....	2.3kg

## FM

Signal Noise Ratio.....	55dB
Residual Noise Sensitivity(S/N=30dB).....	20dB $\mu$ V
Frequency Response( $\pm$ 3dB).....	40Hz~12.5KHz
Station Seeking Level.....	20~30dB $\mu$ V
Distortion.....	1.5%
Stereo Separation(1KHz).....	20dB
Antenna Impedance.....	75 $\Omega$

## AM

Residual Noise Sensitivity (S/N=20dB).....	40dB $\mu$ V
Selectivity ( $\pm$ 9KHz) .....	50dB

## DVD Player

Signal / Noise Ratio.....	90dB
Dynamic Range.....	90dB
Distortion(line out).....	0.1%
Frequency Response( $\pm$ 3dB).....	20Hz~20KHz
Max Output Power.....	4×45W
Load Impedance.....	4 $\Omega$

## AUX IN

Distortion.....	0.5%
Frequency Response( $\pm$ 3dB).....	20Hz~20KHz
Audio Input Level.....	0.4Vrms

## Audio

Audio Output Impedance.....	200 $\Omega$
Audio Output Level.....	2Vrms(Max)
(Under normal audio input level and maximum volume)	

# Specifications

## Video

Normal Video Input Level(CVBS).....	1.0±0.2V
Video Input Impedance.....	75Ω
Video Output Impedance.....	75Ω
Video Output Level.....	1.0±0.2V
(Under normal video input level)	

## TFT Monitor

Screen Diagonal.....	7 inches
Usable Display Area.....	154.1(W) × 87.0 (H)
Resolution.....	1440 (W) × 234 (H)
Brightness.....	400cd/m <sup>2</sup>
(Measure the center brightness after 30 minutes)	
Contrast.....	300( TYP. )
Response Time	
Rise.....	12ms
Fall.....	18ms
Viewing Angle	
From Top.....	40°
From bottom.....	65°
Horizontally .....	±65°
LCD Life Cycle.....	10000 hours(at 25°C)

## Environment

Operating Temperature.....	-10°C~ + 60°C
Storing Temperature.....	-20°C~ + 70°C
Operating Humidity.....	45%~80%RH
Storing Humidity.....	30%~90%RH

※ Specifications are subject to possible modifications for improvement without further notice.

# Appendix

## Region Code

According to DVD sale region, the whole world is divided into six regions. A DVD disc can be played back only when its region code is compatible with that of the player in use.

Region 1: USA, Canada, East Pacific Ocean Islands;

Region 2: Japan, West Europe, North Europe, Egypt, South Africa, Middle East;

Region 3: Taiwan of China, Hong Kong of China, South Korea, Thailand, Indonesia, South East Asia;

Region 4: Australia, New Zealand, Mid & south America, South Pacific Ocean Islands/Oceania;

Region 5: Russia, Mongolia, India, Middle Asia, East Europe, North Korea, North Africa, North West Asia;

Region 6: Chinese Mainland.

## Cautions of disc using

### 1) DO NOT use irregular shaped disc

### 2) Disc Cleaning

Use a dry, soft cloth to wipe the disc from center to edge, only neutral detergent can be used.

### 3) When playing a new disc

New disc may have some rough spots around the inner and outer edges. If such a disc is used, remove these rough spots with a pencil or ball-point pen, etc.

# Appendix

## Wiring Diagram

